

NPN Silicon Phototransistors

Types OP501, OP501SLD, OP501SLC, OP501SLB, OP501SLA

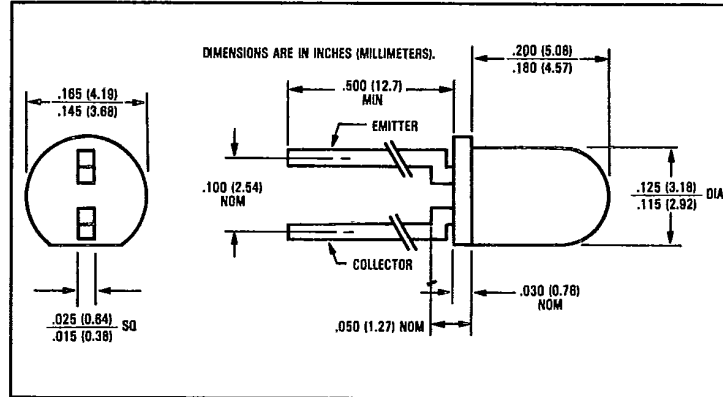
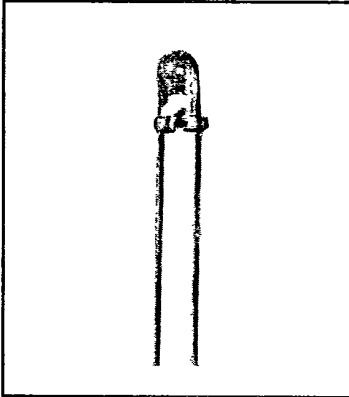

Features

- 0.100" (2.54 mm) lead spacing
- Wide range of collector currents
- Lensed for high sensitivity

Description

The OP501 and OP501SLD through SLA each consist of an NPN silicon phototransistor mounted in a lensed, clear plastic, and locking package. The lensing effect of the package allows an acceptance half angle of 8° measured from the optical axis to the half power point. This series is identical to the OP500 except for lead spacing. It is mechanically and spectrally matched to the OP160SL and OP161SL series of infrared emitting diodes.

Absolute Maximum Ratings (T_A = 25°C unless otherwise noted)

Collector-Emitter Voltage	30 V
Emitter-Collector Voltage	5.0 V
Storage and Operating Temperature Range	-40°C to +100°C
Lead Soldering Temperature (1/16 inch [1.6 mm] from case for 5 sec. with soldering iron) ⁽¹⁾	240°C
Power Dissipation	100 mW ⁽²⁾

Notes:

- (1) RMA flux is recommended. Duration can be extended to 10 sec. max. when wave soldering.
 - (2) Derate linearly 1.33 mW/°C above 25°C.
 - (3) Junction temperature maintained at 25°C.
 - (4) Light source is an unfiltered tungsten bulb operating at CT = 2870°K or equivalent infrared source.
- (5) To calculate typical collector dark current in μA , use the formula $I_{CE0} = 10^{0.040 T_A - 3.4}$ where T_A is ambient temperature in °C.

Typical Performance Curves

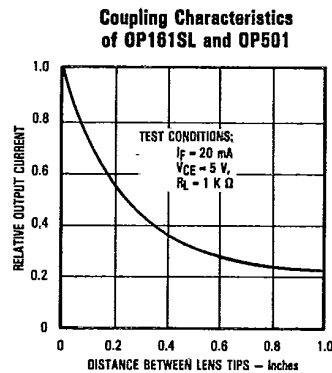
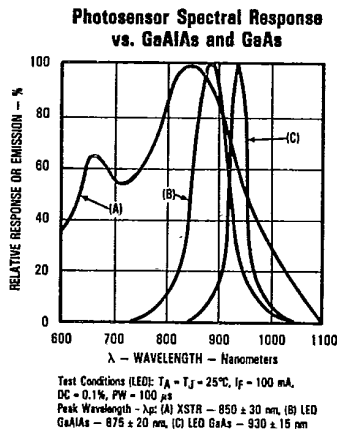

Types OP501, OP501SLD, OP501SLC, OP501SLB, OP501SLA

T-41-61

Electrical Characteristics (T_A = 25°C unless otherwise noted)

Symbol	Parameter	Min.	Typ.	Max.	Units	Test Conditions
I _{C(ON)} ⁽³⁾	On-State Collector Current	OP501 4.0		24	mA	V _{CE} = 5.0 V, E _g = 20 mW/cm ²⁽⁴⁾
		OP501SLD 10.0		35	mA	V _{CE} = 5.0 V, E _g = 20 mW/cm ²⁽⁴⁾
		OP501SLC 17.0		50	mA	V _{CE} = 5.0 V, E _g = 20 mW/cm ²⁽⁴⁾
		OP501SLB 25			mA	V _{CE} = 5.0 V, E _g = 20 mW/cm ²⁽⁴⁾
		OP501SLA 40			mA	V _{CE} = 5.0 V, E _g = 20 mW/cm ²⁽⁴⁾
ΔI _C /ΔT	Relative I _C Changes with Temperature		1.00		%/°C	V _{CE} = 5.0 V, E _g = 1.00 mW/cm ² , λ = 875 nm
I _{CE0} ⁽⁵⁾	Collector Dark Current			100	nA	V _{CE} = 10.0 V, E _g = 0
V _{(BR)CEO}	Collector-Emitter Breakdown Voltage	30			V	I _C = 100 μA
V _{(BR)ECO}	Emitter-Collector Breakdown Voltage	5.0			V	I _E = 100 μA
V _{CE(SAT)} ⁽³⁾	Collector-Emitter Saturation Voltage			0.40	V	I _C = 500 μA, E _g = 20 mW/cm ²⁽⁴⁾



Typical Performance Curves

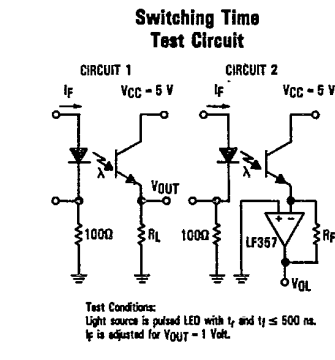
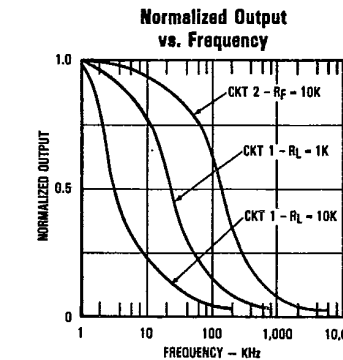
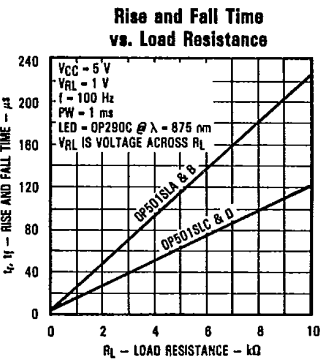
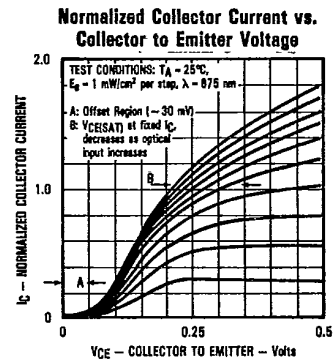
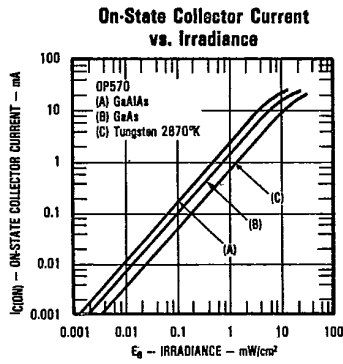
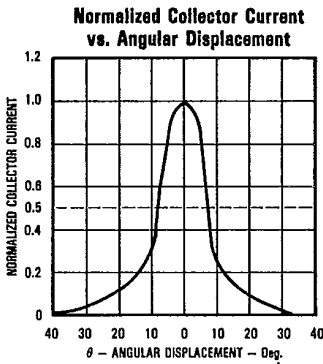

TRW reserves the right to make changes at any time in order to improve design and to supply the best product possible.

Optoelectronics Division, TRW Electronic Components Group, 1215 W. Crosby Rd., Carrollton, TX 75006 (214) 323-2200, TLX 6716032 or 215849 © TRW Inc. 1985, 1982. TRW is the name and mark of TRW Inc. Printed in U.S.A.